

# 第16回豊饒の海 大分県小学生バドミントン大会

2022. 05. 15 杵築市文化体育館

種 目	優 勝	準 優 勝	三 位	四 位
6年男子複	まきだいち 牧 大地 むとういくま 武藤 郁大 (BC春日)	まつお かなた 松尾 奏風 よしなが らいは 吉長 雷覇 (IKEスクール)	ふかまち りく 深町 凌玖 かんざき たいむ 神崎 太結 (三芳ジュニア)	しまかわ ともすけ 嶋川 智介 まつもと ゆうた 松本 裕太 (BC臼杵)
5年男子複	みたらい すばる 御手洗 希星 いしい はるま 石井 晴誠 (高尾山ファミリー)	いけなが ゆうあ 池永 悠吾 よこざわ はるき 横澤 明季 (IKEスクール)	いしかわ ひかる 石川 輝 とだか こたろう 戸高 鼓太郎 (中島ジュニア)	うらべりひと 浦邊 カー しまむら しゅうご 嶋村 柊吾 (臼杵南ジュニア)
4年以下男子複	あんどう りく 安藤 颯空 あおやま ひかる 青山 暉 (中島ジュニア)	さとう きよはる 佐藤 清春 たかまつ げんき 高松 元輝 (若宮ジュニア)	おおた りょうや 太田 稜也 やまむら りく 山村 竜久 (判田ジュニア)	たかなみ るか 高波 瑠禾 すがわら ろあ 菅原 楼蒼 (IKEスクール)
6年女子複	まるい ゆな 丸井 悠菜 あんどう さな 安藤 颯花 (中島ジュニア)	がもう さな 蒲生 咲菜 かんざき みう 神崎 心優 (IKEスクール)	ひやかわ ゆき 冷川 結希 さかもと こあ 坂本 倅愛 (三芳ジュニア)	くさのしづき 草野 詩月 くりやまじゅり 栗山 樹梨 (光岡ジュニア)
5年女子複	にわせ れい 庭瀬 怜 きら わかば 吉良 和椋 (JBC鶴谷)	さとう あやめ 佐藤 綺芽 おの まなみ 小野 愛美 (坂ノ市JBC)	くろだ わか 黒田 和花 えびな しほ 海老名 葉帆 (中島ジュニア)	でぐち りん 出口 凜 たかまつ いろは 高松 彩羽 (東大分JBC)
4年以下女子複	さむら おと 左村 桜都 いわおりの 岩尾 梨乃 (SJひた)	ざいつ あみ 財津 杏実 ごとう りか 後藤 梨花 (IKEスクール)	ふくだ ゆうか 福田 侑加 ふくだ じゅんな 福田 純菜 (別府フレンドリージュニア)	かなざき このん 金崎 心音 なかしま ののか 中島 希乃花 (ONOジュニア)

◎4年生男子ダブルス 順位決定戦

順位	氏名		所属
5位	高倉 陽希	小畑 陽希	三芳ジュニア
6位	飯干晴仁	佐藤海翔	三重JBC
7位	安藤光	川崎蓮士	BC臼杵
8位	大石達也	稲田權李	大在ジュニア

◎4年生女子ダブルス 順位決定戦

順位	氏名		所属
5位	平川喜衣愛	佐藤侑奈	三重JBC
6位	用松佳純	藤美麗	中島ジュニア
7位	草野葉月	大庭夏	光岡ジュニア
8位	西村彩帆	近藤祐歩	大在ジュニア

◎5年生男子ダブルス 順位決定戦

順位	氏名		所属
5位	馬田雄晟	古寺智武	宇佐ジュニア
6位	伊藤央人	田中利來	植田ジュニア
7位	前田恵吾	立田悠真	臼杵TBC
8位	松田斗輝	白石百風	咸宜ジュニア

◎5年生女子ダブルス 順位決定戦

順位	氏名		所属
5位	平川来愛	佐藤乃愛	三重JBC
6位	桑鶴莉々	松田悠那	咸宜ジュニア
7位	二村倫央	阿部実采	日出ジュニア
8位	三重野優美	佐々木彩音	大在ジュニア

◎6年生男子ダブルス 順位決定戦

順位	氏名		所属
5位	左村希之助	遠藤端歩	SJひた
6位	渡辺健斗	中尾友哉	植田ジュニア
7位	詫間信之介	酒井葵	臼杵南ジュニア
8位	後藤壱騎	宇都宮佑太郎	別府フレンドリージュニア

◎6年生女子ダブルス 順位決定戦

順位	氏名		所属
5位	長野希美	戸高雫	日出ジュニア
6位	佐藤唯愛	小野琴美	若宮ジュニア
7位	柚木愛唯	嶋田七菜	大在ジュニア
8位	立川さくら	小野結衣	リトルソロック

◎4年生以下男子ダブルス 順位決定戦

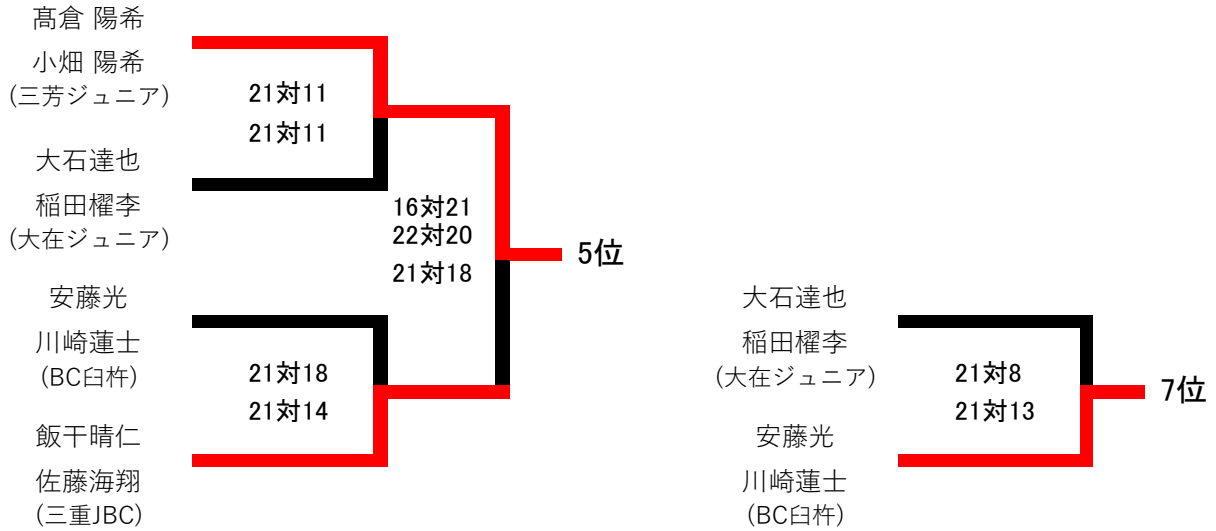

◎5年生男子ダブルス 順位決定戦

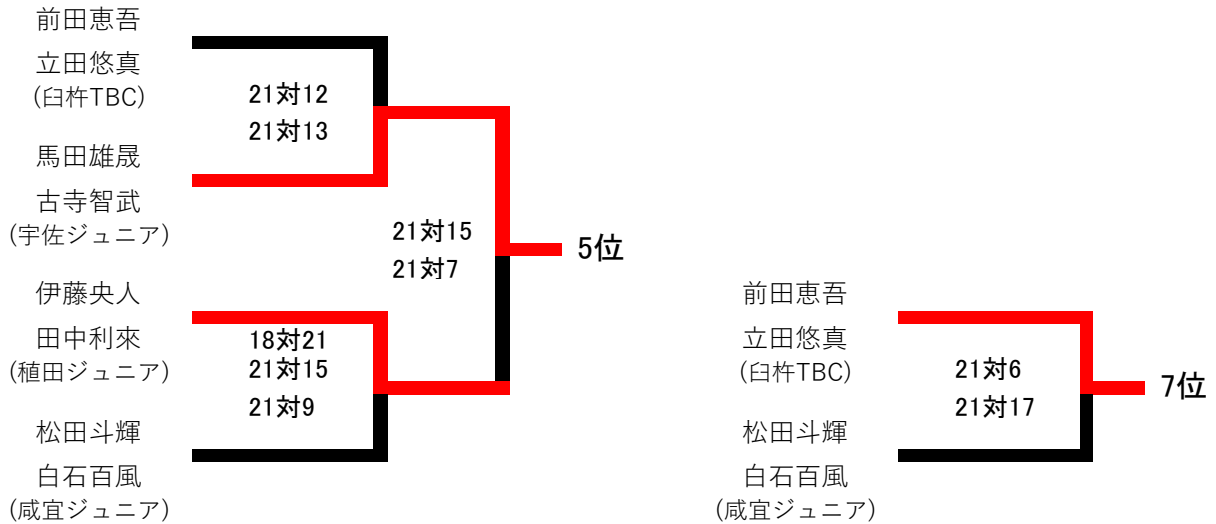

◎6年生男子ダブルス 順位決定戦

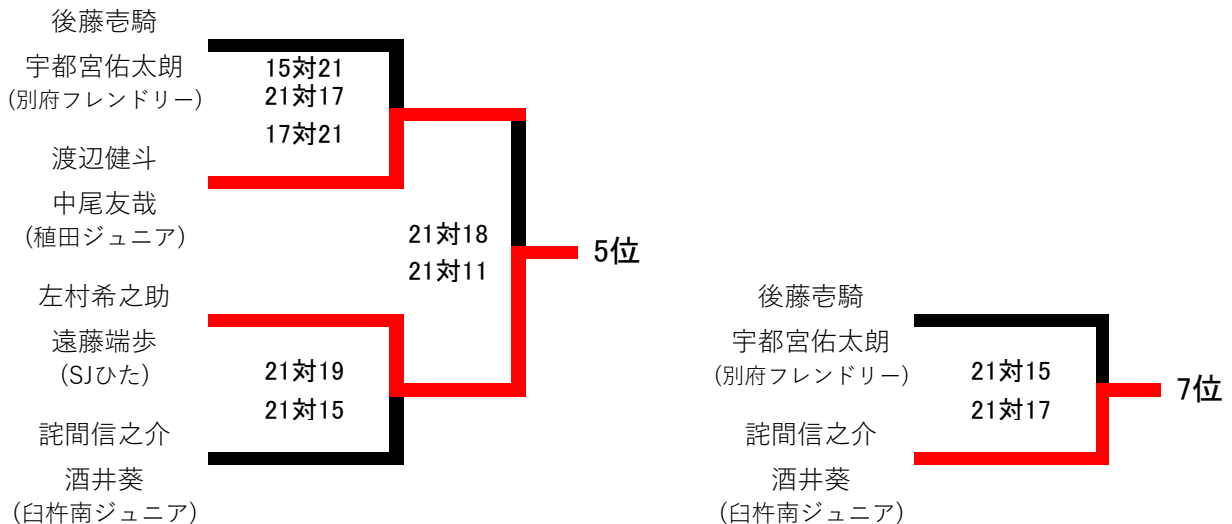

◎4年生以下女子ダブルス 順位決定戦

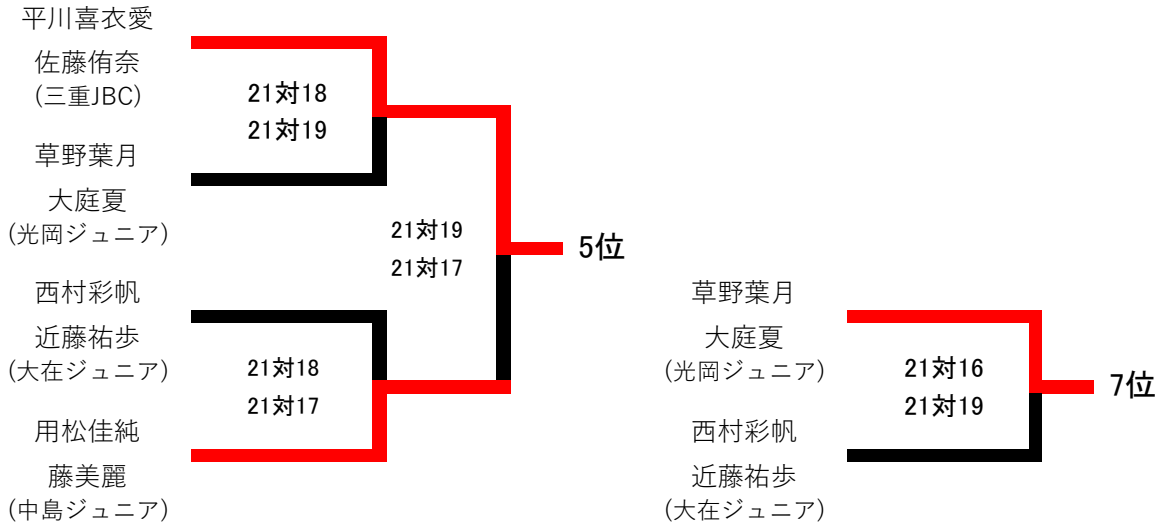

◎5年生女子ダブルス 順位決定戦

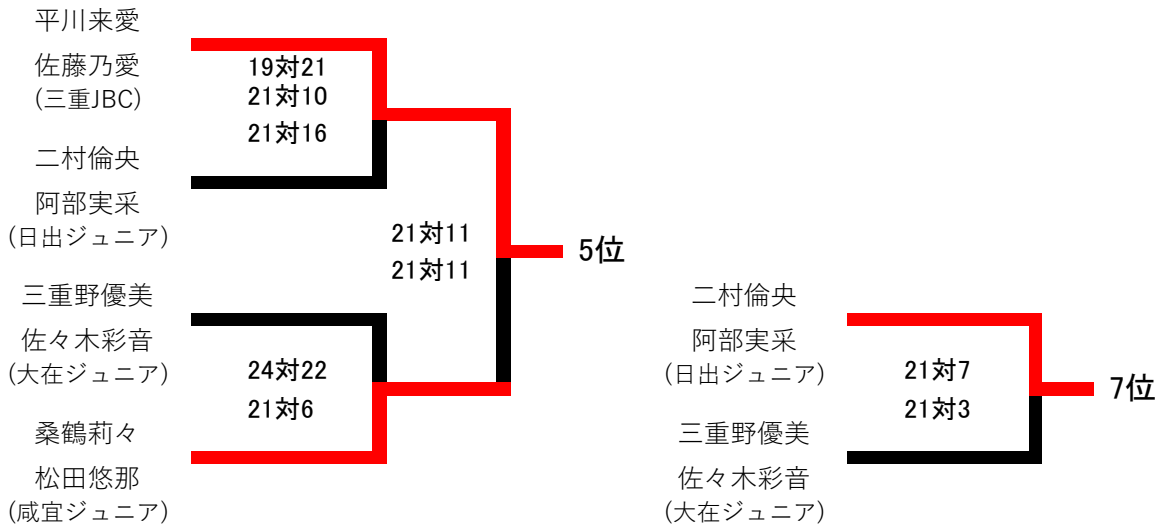

◎6年生女子ダブルス 順位決定戦

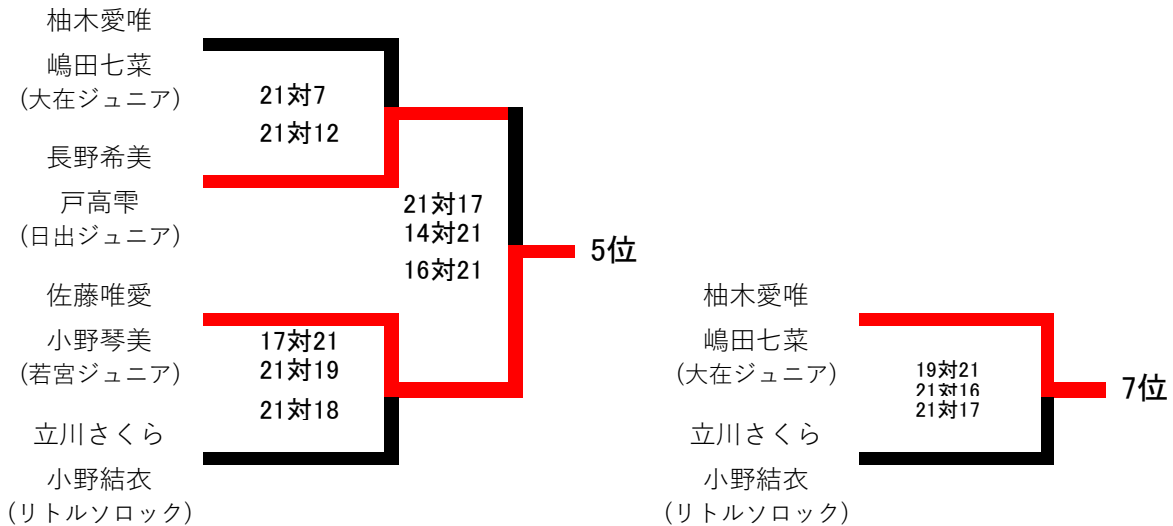

## 6年男子ダブルス

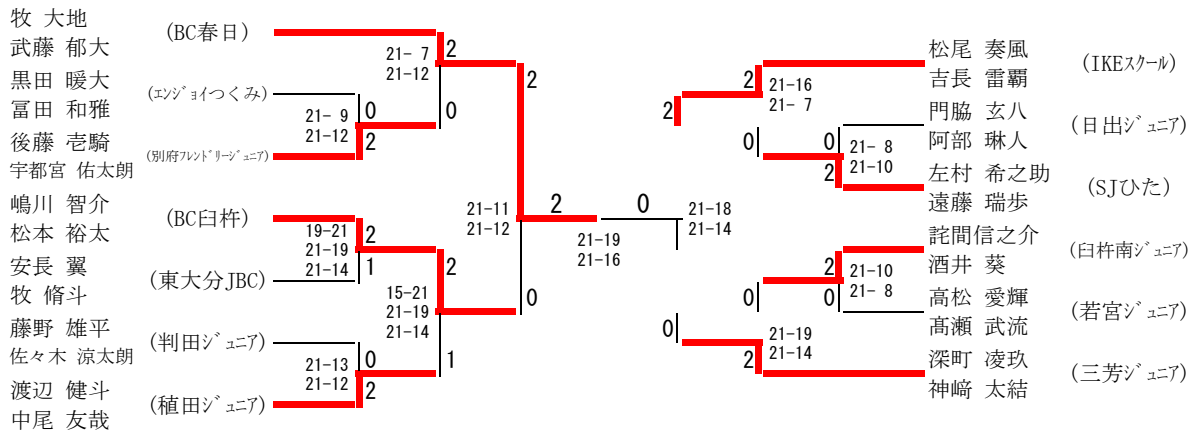

### 三位決定戦

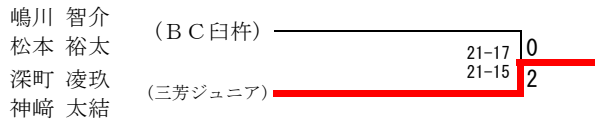

## 5年男子ダブルス

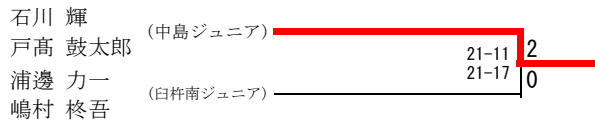
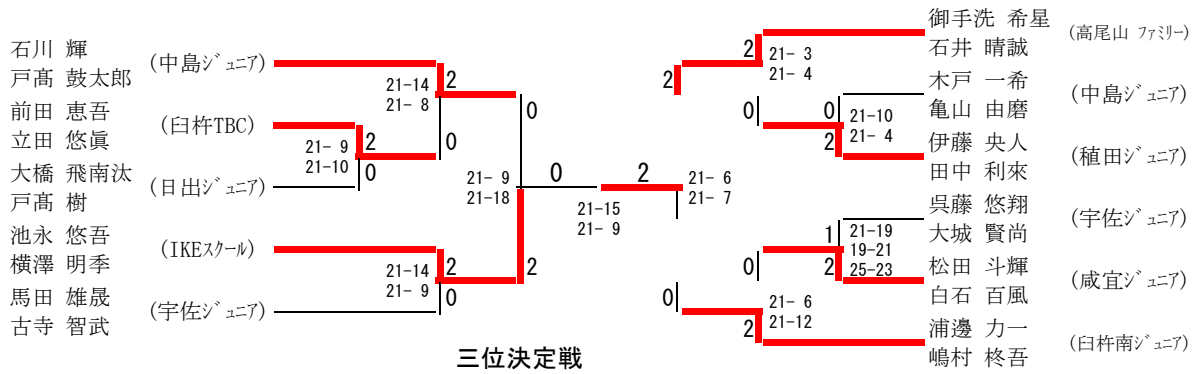

## 4年以下男子ダブルス

安藤 颯空 青山 暉 藤井 一翔 岩崎 元登 高倉 陽希 小畑 頼功 大石 達也 稲田 權李 太田 稜也 山村 竜久	(中島シニア) (坂ノ市JBC) (三芳シニア) (大在シニア) (判田シニア)	<table style="margin: auto; border-collapse: collapse;"> <tr> <td style="border-right: 1px solid black; padding: 5px;">21-4</td> <td style="padding: 5px;">2</td> <td rowspan="2" style="border-right: 1px solid black; padding: 5px;">2</td> <td rowspan="2" style="padding: 5px;">0</td> <td rowspan="2" style="border-right: 1px solid black; padding: 5px;">2</td> <td rowspan="2" style="padding: 5px;">0</td> <td rowspan="2" style="border-right: 1px solid black; padding: 5px;">2</td> <td rowspan="2" style="padding: 5px;">0</td> <td rowspan="2" style="border-right: 1px solid black; padding: 5px;">2</td> <td rowspan="2" style="padding: 5px;">0</td> <td rowspan="2" style="border-right: 1px solid black; padding: 5px;">2</td> <td rowspan="2" style="padding: 5px;">0</td> </tr> <tr> <td style="border-right: 1px solid black; padding: 5px;">21-7</td> <td style="padding: 5px;">0</td> <td style="border-right: 1px solid black; padding: 5px;">2</td> <td style="padding: 5px;">0</td> <td style="border-right: 1px solid black; padding: 5px;">2</td> <td style="padding: 5px;">0</td> <td style="border-right: 1px solid black; padding: 5px;">2</td> <td style="padding: 5px;">0</td> </tr> <tr> <td style="border-right: 1px solid black; padding: 5px;">21-14</td> <td style="padding: 5px;">1</td> <td rowspan="2" style="border-right: 1px solid black; padding: 5px;">2</td> <td rowspan="2" style="padding: 5px;">0</td> <td rowspan="2" style="border-right: 1px solid black; padding: 5px;">2</td> <td rowspan="2" style="padding: 5px;">0</td> <td rowspan="2" style="border-right: 1px solid black; padding: 5px;">2</td> <td rowspan="2" style="padding: 5px;">0</td> <td rowspan="2" style="border-right: 1px solid black; padding: 5px;">2</td> <td rowspan="2" style="padding: 5px;">0</td> <td rowspan="2" style="border-right: 1px solid black; padding: 5px;">2</td> <td rowspan="2" style="padding: 5px;">0</td> </tr> <tr> <td style="border-right: 1px solid black; padding: 5px;">19-21</td> <td style="padding: 5px;">2</td> <td style="border-right: 1px solid black; padding: 5px;">2</td> <td style="padding: 5px;">0</td> <td style="border-right: 1px solid black; padding: 5px;">2</td> <td style="padding: 5px;">0</td> <td style="border-right: 1px solid black; padding: 5px;">2</td> <td style="padding: 5px;">0</td> </tr> <tr> <td style="border-right: 1px solid black; padding: 5px;">21-13</td> <td style="padding: 5px;">2</td> <td rowspan="2" style="border-right: 1px solid black; padding: 5px;">2</td> <td rowspan="2" style="padding: 5px;">0</td> <td rowspan="2" style="border-right: 1px solid black; padding: 5px;">2</td> <td rowspan="2" style="padding: 5px;">0</td> <td rowspan="2" style="border-right: 1px solid black; padding: 5px;">2</td> <td rowspan="2" style="padding: 5px;">0</td> <td rowspan="2" style="border-right: 1px solid black; padding: 5px;">2</td> <td rowspan="2" style="padding: 5px;">0</td> <td rowspan="2" style="border-right: 1px solid black; padding: 5px;">2</td> <td rowspan="2" style="padding: 5px;">0</td> </tr> <tr> <td style="border-right: 1px solid black; padding: 5px;">21-10</td> <td style="padding: 5px;">0</td> <td style="border-right: 1px solid black; padding: 5px;">2</td> <td style="padding: 5px;">0</td> <td style="border-right: 1px solid black; padding: 5px;">2</td> <td style="padding: 5px;">0</td> <td style="border-right: 1px solid black; padding: 5px;">2</td> <td style="padding: 5px;">0</td> </tr> <tr> <td style="border-right: 1px solid black; padding: 5px;">21-8</td> <td style="padding: 5px;">0</td> <td rowspan="2" style="border-right: 1px solid black; padding: 5px;">2</td> <td rowspan="2" style="padding: 5px;">0</td> <td rowspan="2" style="border-right: 1px solid black; padding: 5px;">2</td> <td rowspan="2" style="padding: 5px;">0</td> <td rowspan="2" style="border-right: 1px solid black; padding: 5px;">2</td> <td rowspan="2" style="padding: 5px;">0</td> <td rowspan="2" style="border-right: 1px solid black; padding: 5px;">2</td> <td rowspan="2" style="padding: 5px;">0</td> <td rowspan="2" style="border-right: 1px solid black; padding: 5px;">2</td> <td rowspan="2" style="padding: 5px;">0</td> </tr> <tr> <td style="border-right: 1px solid black; padding: 5px;">21-11</td> <td style="padding: 5px;">2</td> <td style="border-right: 1px solid black; padding: 5px;">2</td> <td style="padding: 5px;">0</td> <td style="border-right: 1px solid black; padding: 5px;">2</td> <td style="padding: 5px;">0</td> <td style="border-right: 1px solid black; padding: 5px;">2</td> <td style="padding: 5px;">0</td> </tr> <tr> <td style="border-right: 1px solid black; padding: 5px;">21-10</td> <td style="padding: 5px;">2</td> <td rowspan="2" style="border-right: 1px solid black; padding: 5px;">2</td> <td rowspan="2" style="padding: 5px;">0</td> <td rowspan="2" style="border-right: 1px solid black; padding: 5px;">2</td> <td rowspan="2" style="padding: 5px;">0</td> <td rowspan="2" style="border-right: 1px solid black; padding: 5px;">2</td> <td rowspan="2" style="padding: 5px;">0</td> <td rowspan="2" style="border-right: 1px solid black; padding: 5px;">2</td> <td rowspan="2" style="padding: 5px;">0</td> <td rowspan="2" style="border-right: 1px solid black; padding: 5px;">2</td> <td rowspan="2" style="padding: 5px;">0</td> </tr> <tr> <td style="border-right: 1px solid black; padding: 5px;">21-8</td> <td style="padding: 5px;">0</td> <td style="border-right: 1px solid black; padding: 5px;">2</td> <td style="padding: 5px;">0</td> <td style="border-right: 1px solid black; padding: 5px;">2</td> <td style="padding: 5px;">0</td> <td style="border-right: 1px solid black; padding: 5px;">2</td> <td style="padding: 5px;">0</td> </tr> <tr> <td style="border-right: 1px solid black; padding: 5px;">21-10</td> <td style="padding: 5px;">2</td> <td rowspan="2" style="border-right: 1px solid black; padding: 5px;">2</td> <td rowspan="2" style="padding: 5px;">0</td> <td rowspan="2" style="border-right: 1px solid black; padding: 5px;">2</td> <td rowspan="2" style="padding: 5px;">0</td> <td rowspan="2" style="border-right: 1px solid black; padding: 5px;">2</td> <td rowspan="2" style="padding: 5px;">0</td> <td rowspan="2" style="border-right: 1px solid black; padding: 5px;">2</td> <td rowspan="2" style="padding: 5px;">0</td> <td rowspan="2" style="border-right: 1px solid black; padding: 5px;">2</td> <td rowspan="2" style="padding: 5px;">0</td> </tr> <tr> <td style="border-right: 1px solid black; padding: 5px;">21-11</td> <td style="padding: 5px;">2</td> <td style="border-right: 1px solid black; padding: 5px;">2</td> <td style="padding: 5px;">0</td> <td style="border-right: 1px solid black; padding: 5px;">2</td> <td style="padding: 5px;">0</td> <td style="border-right: 1px solid black; padding: 5px;">2</td> <td style="padding: 5px;">0</td> </tr> <tr> <td style="border-right: 1px solid black; padding: 5px;">21-8</td> <td style="padding: 5px;">0</td> <td rowspan="2" style="border-right: 1px solid black; padding: 5px;">2</td> <td rowspan="2" style="padding: 5px;">0</td> <td rowspan="2" style="border-right: 1px solid black; padding: 5px;">2</td> <td rowspan="2" style="padding: 5px;">0</td> <td rowspan="2" style="border-right: 1px solid black; padding: 5px;">2</td> <td rowspan="2" style="padding: 5px;">0</td> <td rowspan="2" style="border-right: 1px solid black; padding: 5px;">2</td> <td rowspan="2" style="padding: 5px;">0</td> <td rowspan="2" style="border-right: 1px solid black; padding: 5px;">2</td> <td rowspan="2" style="padding: 5px;">0</td> </tr> <tr> <td style="border-right: 1px solid black; padding: 5px;">23-21</td> <td style="padding: 5px;">2</td> <td style="border-right: 1px solid black; padding: 5px;">2</td> <td style="padding: 5px;">0</td> <td style="border-right: 1px solid black; padding: 5px;">2</td> <td style="padding: 5px;">0</td> <td style="border-right: 1px solid black; padding: 5px;">2</td> <td style="padding: 5px;">0</td> </tr> <tr> <td style="border-right: 1px solid black; padding: 5px;">21-13</td> <td style="padding: 5px;">2</td> <td rowspan="2" style="border-right: 1px solid black; padding: 5px;">2</td> <td rowspan="2" style="padding: 5px;">0</td> <td rowspan="2" style="border-right: 1px solid black; padding: 5px;">2</td> <td rowspan="2" style="padding: 5px;">0</td> <td rowspan="2" style="border-right: 1px solid black; padding: 5px;">2</td> <td rowspan="2" style="padding: 5px;">0</td> <td rowspan="2" style="border-right: 1px solid black; padding: 5px;">2</td> <td rowspan="2" style="padding: 5px;">0</td> <td rowspan="2" style="border-right: 1px solid black; padding: 5px;">2</td> <td rowspan="2" style="padding: 5px;">0</td> </tr> <tr> <td style="border-right: 1px solid black; padding: 5px;">21-16</td> <td style="padding: 5px;">2</td> <td style="border-right: 1px solid black; padding: 5px;">2</td> <td style="padding: 5px;">0</td> <td style="border-right: 1px solid black; padding: 5px;">2</td> <td style="padding: 5px;">0</td> <td style="border-right: 1px solid black; padding: 5px;">2</td> <td style="padding: 5px;">0</td> </tr> <tr> <td style="border-right: 1px solid black; padding: 5px;">21-9</td> <td style="padding: 5px;">0</td> <td rowspan="2" style="border-right: 1px solid black; padding: 5px;">2</td> <td rowspan="2" style="padding: 5px;">0</td> <td rowspan="2" style="border-right: 1px solid black; padding: 5px;">2</td> <td rowspan="2" style="padding: 5px;">0</td> <td rowspan="2" style="border-right: 1px solid black; padding: 5px;">2</td> <td rowspan="2" style="padding: 5px;">0</td> <td rowspan="2" style="border-right: 1px solid black; padding: 5px;">2</td> <td rowspan="2" style="padding: 5px;">0</td> <td rowspan="2" style="border-right: 1px solid black; padding: 5px;">2</td> <td rowspan="2" style="padding: 5px;">0</td> </tr> <tr> <td style="border-right: 1px solid black; padding: 5px;">21-9</td> <td style="padding: 5px;">2</td> <td style="border-right: 1px solid black; padding: 5px;">2</td> <td style="padding: 5px;">0</td> <td style="border-right: 1px solid black; padding: 5px;">2</td> <td style="padding: 5px;">0</td> <td style="border-right: 1px solid black; padding: 5px;">2</td> <td style="padding: 5px;">0</td> </tr> </table>	21-4	2	2	0	2	0	2	0	2	0	2	0	21-7	0	2	0	2	0	2	0	21-14	1	2	0	2	0	2	0	2	0	2	0	19-21	2	2	0	2	0	2	0	21-13	2	2	0	2	0	2	0	2	0	2	0	21-10	0	2	0	2	0	2	0	21-8	0	2	0	2	0	2	0	2	0	2	0	21-11	2	2	0	2	0	2	0	21-10	2	2	0	2	0	2	0	2	0	2	0	21-8	0	2	0	2	0	2	0	21-10	2	2	0	2	0	2	0	2	0	2	0	21-11	2	2	0	2	0	2	0	21-8	0	2	0	2	0	2	0	2	0	2	0	23-21	2	2	0	2	0	2	0	21-13	2	2	0	2	0	2	0	2	0	2	0	21-16	2	2	0	2	0	2	0	21-9	0	2	0	2	0	2	0	2	0	2	0	21-9	2	2	0	2	0	2	0	高波 瑠禾 菅原 楼蒼 安藤 光 川崎 蓮士 飯干 晴仁 佐藤 海翔 佐藤 清春 高松 元輝	(IKEスクール) (BC白杵) (三重JBC) (若宮シニア)
21-4	2	2	0	2											0	2	0	2	0	2	0																																																																																																																																																																			
21-7	0				2	0	2	0	2	0																																																																																																																																																																														
21-14	1	2	0	2	0	2	0	2	0	2	0																																																																																																																																																																													
19-21	2											2	0	2	0	2	0																																																																																																																																																																							
21-13	2	2	0	2	0	2	0	2	0	2	0																																																																																																																																																																													
21-10	0											2	0	2	0	2	0																																																																																																																																																																							
21-8	0	2	0	2	0	2	0	2	0	2	0																																																																																																																																																																													
21-11	2											2	0	2	0	2	0																																																																																																																																																																							
21-10	2	2	0	2	0	2	0	2	0	2	0																																																																																																																																																																													
21-8	0											2	0	2	0	2	0																																																																																																																																																																							
21-10	2	2	0	2	0	2	0	2	0	2	0																																																																																																																																																																													
21-11	2											2	0	2	0	2	0																																																																																																																																																																							
21-8	0	2	0	2	0	2	0	2	0	2	0																																																																																																																																																																													
23-21	2											2	0	2	0	2	0																																																																																																																																																																							
21-13	2	2	0	2	0	2	0	2	0	2	0																																																																																																																																																																													
21-16	2											2	0	2	0	2	0																																																																																																																																																																							
21-9	0	2	0	2	0	2	0	2	0	2	0																																																																																																																																																																													
21-9	2											2	0	2	0	2	0																																																																																																																																																																							

### 三位決定戦

太田 稜也 山村 竜久 高波 瑠禾 菅原 楼蒼	(判田ジュニア) (IKEスクール)	<table style="margin: auto; border-collapse: collapse;"> <tr> <td style="border-right: 1px solid black; padding: 5px;">21-15</td> <td style="padding: 5px;">2</td> </tr> <tr> <td style="border-right: 1px solid black; padding: 5px;">21-14</td> <td style="padding: 5px;">0</td> </tr> </table>	21-15	2	21-14	0	
21-15	2						
21-14	0						

# 6年女子ダブルス

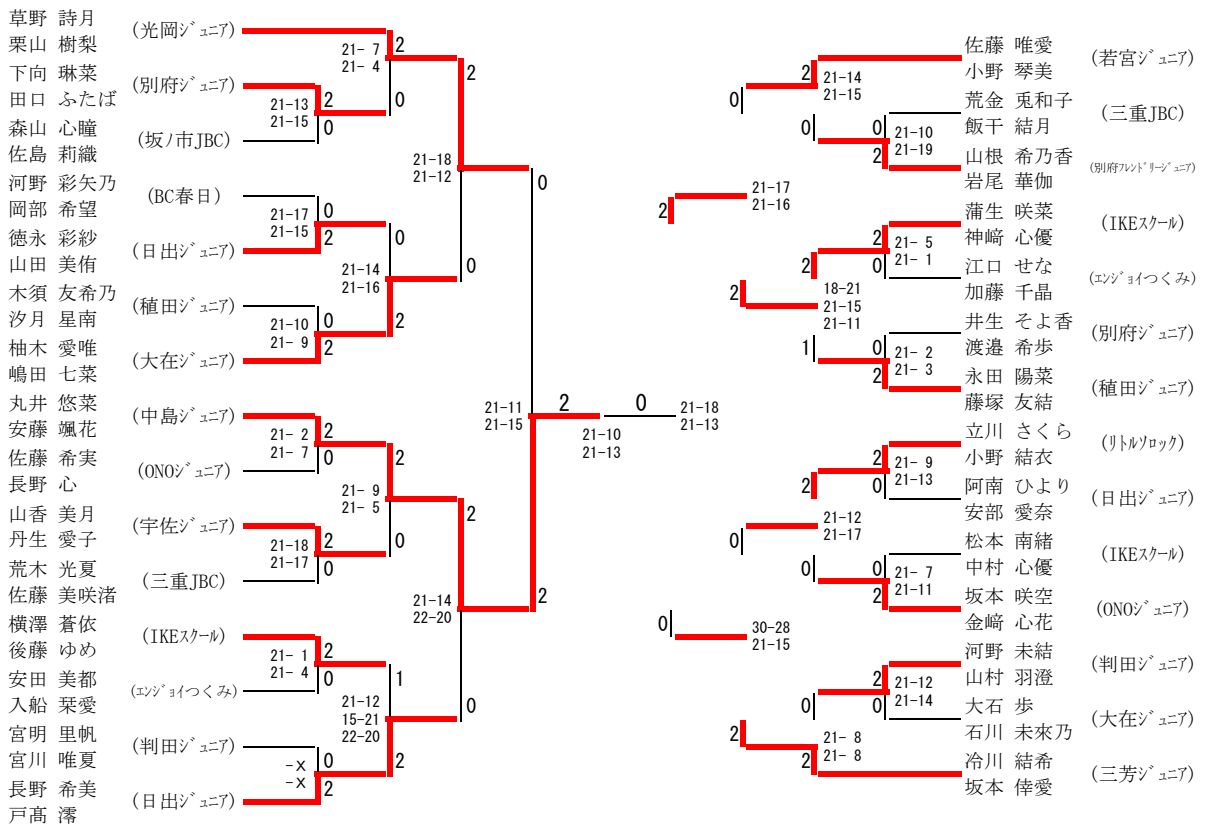

## 三位決定戦

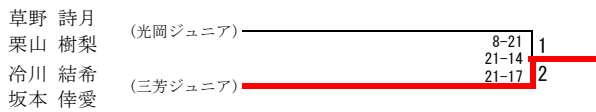



# 5年女子ダブルス

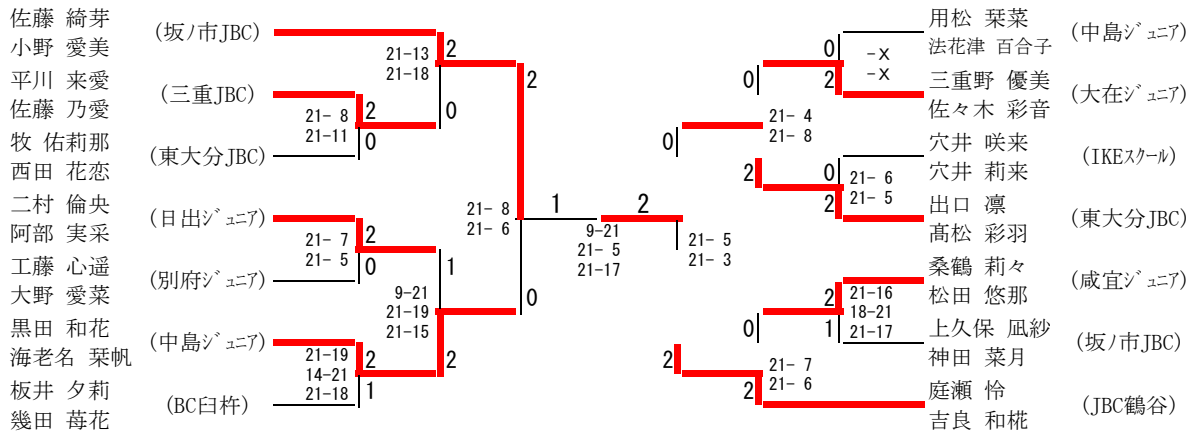

## 三位決定戦

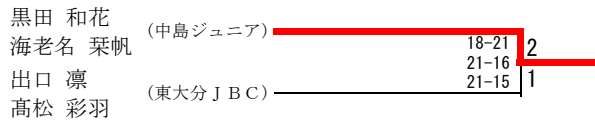

# 4年以下女子ダブルス

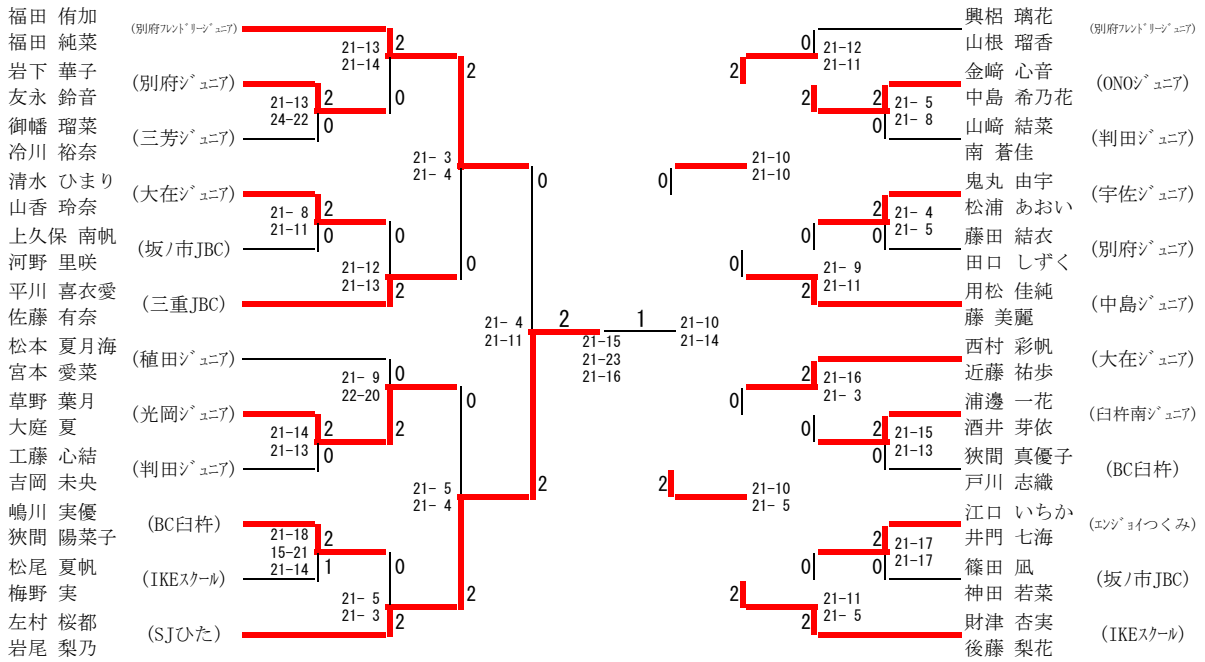

## 三位決定戦

